

ROTA-TIP™ Replaceable Tips



- Solid Carbide replaceable blades.
- Tool body remains in place when changing blades, thus reducing down-time.
- Straight cutters have blades with two or four cutting edges, allowing them to be rotated and locked in identical positions.
- 1/2" shank tools are ideal for use in production applications.
- Clear economical advantage over conventional brazed tip tooling.

Single Replaceable Blade

- The single blade can be rotated 180° to give double the life of a conventional tool.
- Refs. RT/11, RT/11M & RT/13 are ideally suited for use with Trend Combi worktop jigs.
- Ref. RT/13 is ideal for Trend KWJ900 worktop jig.
- Refs. RT/11M & RT/12M have a shorter shank, designed for use with Makita 3600B & 3612BR, Ryobi and Hitachi routers.
- ▲ Refs. RT/13 to be used on chipboard only.
- ▲ Refs. RT/15, 16, 17, 40 & 41 are suitable for fixed head machines only.



See page 14 for spare blades.

D inch	D mm	C mm	OL mm	Product Ref.	Shank Diameter	
					1/4"	1/2"
1/2	12.7	29.5	66.0	RT/03	£35.91	-
-	12.0	29.5	76.0	RT/04	-	£56.81
1/2	12.7	29.5	76.0	RT/10	-	£53.55
1/2	12.7	29.5*	100.0	RT/11	-	£64.58
1/2	12.7	29.5*	89.0	RT/11M	-	£64.58
1/2	12.7	49.5	100.0	RT/13	-	£73.40
-	14.0	29.5	76.0	RT/05	-	£56.81
-	15.0	29.5	76.0	RT/06	-	£56.81
5/8	15.9	29.5	88.0	RT/18	-	£56.81
5/8	15.9	49.5	107.0	RT/12	-	£56.28
-	16.0	49.5	90.0	RT/12M	-	£56.28
-	16.0	29.5	88.0	RT/07	-	£56.81
-	18.0	29.5	88.0	RT/08	-	£58.49
3/4	19.1	29.5	88.0	RT/19	-	£59.54
3/4	19.1	49.5	107.0	RT/14	-	£58.49
-	20.0	29.5	88.0	RT/16	-	£60.69
-	22.0	29.5	88.0	RT/17	-	£61.22
7/8	22.2	29.5	76.0	RT/15	-	£54.08

Suitable for plunge cutting.

With Replaceable Plunge Tip

D inch	D mm	C mm	OL mm	Product Ref.	Shank Dia. 1/2"
-	25.0	29.5	86.0	RT/40	£65.10
1	25.4	29.5	86.0	RT/41	£65.10



Ref. RT/11 & RT/11M*
Single 29.5mm blade with relieved neck, giving 50mm length of cut capability when taking a series of passes.

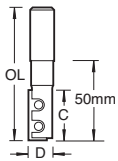

Ref. RT/03 to RT/19

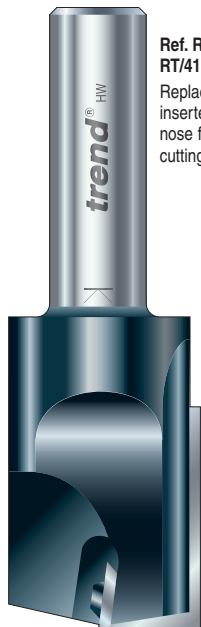
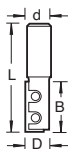

Ref. RT/40 & RT/41
Replaceable inserted tip on nose for plunge cutting.

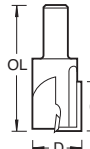

Two Replaceable Blades

- Refs. RT/21 to RT/24 have blades that can be rotated 180° to give double the life of a conventional tool. **Not recommended for plunge cutting unless ramped into workpiece.**
- Refs. RT/21 & RT/23 are used for rough cutting only & have staggered blades.
- ▲ Ref. RT/24 should be used in fixed head machines only.
- Refs. RT/50 & RT/51 are plunge tools with a TC tip braced into nose suitable for plunge cutting & the blades that can be rotated in 90° increments.

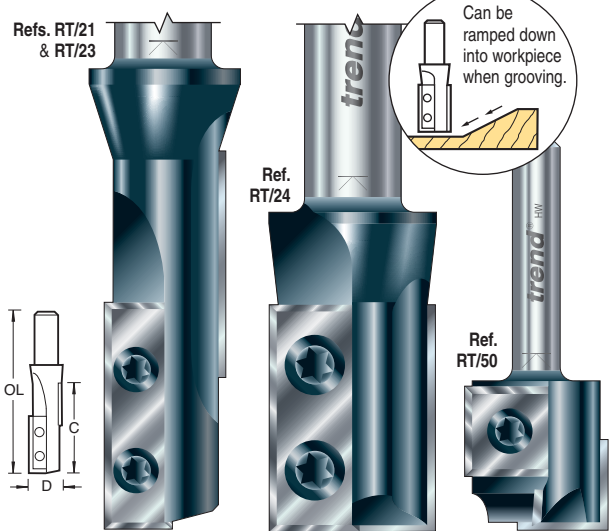

D inch	D mm	C mm	OL mm	Product Ref.	Shank Dia. 1/2"
5/8	15.9	50.0	107.0	RT/21	£67.83
3/4	19.1	50.0	107.0	RT/23	£76.13
7/8	22.2	29.5	88.0	RT/24	£65.63

Staggered with TC Brazed Plunge Tip

D inch	D mm	C mm	Product Ref.	Shank Diameter 1/4"	Shank Diameter 1/2"
3/4	19.1	19.1	RT/50	£61.22	£61.22
7/8	22.2	19.1	RT/51	£62.90	£62.90



Stair Housing

- Designed for stair housing router machines and jigs. Please state LH or RH when ordering.
- ▲ Not for use on Pickles stair trenching machine.

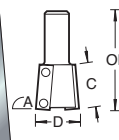
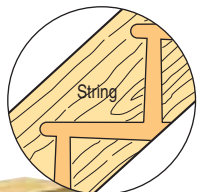

A Deg.	D mm	C mm	OL mm	Product Ref.	Rotation	Shank Dia. 1/2"
95°	22.0	28.0	80.0	RT/323	LH	£111.83
95°	22.0	28.0	80.0	RT/323	RH	£111.83