

# TCT SLOTTING & GROOVING

## One Piece Slotting Cutter

These two wing Tungsten Carbide Tipped slotting cutters are ideal for grooving and rebating operations. A 12.7mm diameter bearing is supplied with every cutter giving a 9.5mm groove depth. Depth of cut can be changed by purchasing alternative bearing sizes. Easy to set-up and use. Hex key is supplied.

**N.B.** The grooving section of this tool cannot be detached from the shank.



Ref. C147

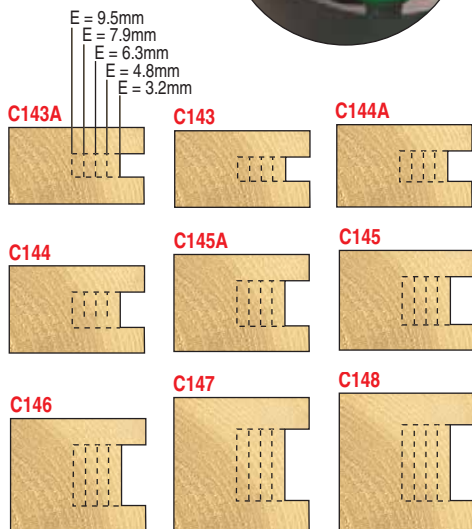
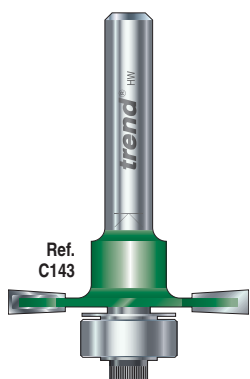
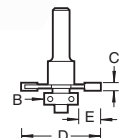
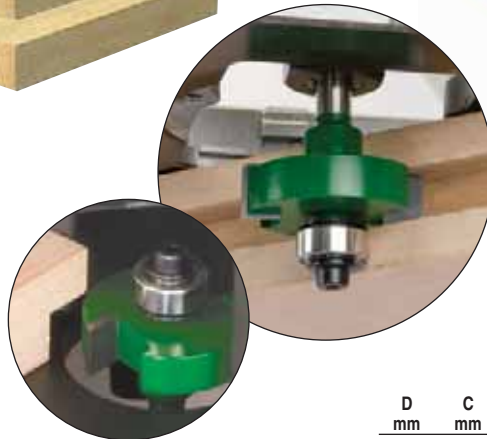
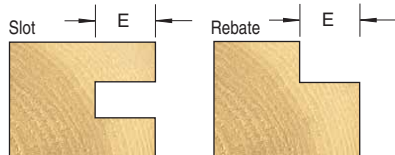

| D mm | C mm | C inch | B mm | Product Ref. | Shank Diameter 1/4" 8mm | Price  |
|------|------|--------|------|--------------|-------------------------|--------|
| 31.8 | 3.0  | -      | 12.7 | <b>C143A</b> | -                       | £19.32 |
| 31.8 | 3.2  | 1/8    | 12.7 | <b>C143</b>  | £19.32                  | -      |
| 31.8 | 4.0  | -      | 12.7 | <b>C144A</b> | -                       | £19.32 |
| 31.8 | 4.7  | 3/16   | 12.7 | <b>C144</b>  | £19.32                  | -      |
| 31.8 | 6.0  | -      | 12.7 | <b>C145A</b> | -                       | £21.00 |
| 31.8 | 6.3  | 1/4    | 12.7 | <b>C145</b>  | £21.00                  | -      |
| 31.8 | 8.0  | 5/16   | 12.7 | <b>C146</b>  | £21.00                  | -      |
| 31.8 | 9.5  | 3/8    | 12.7 | <b>C147</b>  | £22.05                  | -      |
| 31.8 | 10.0 | -      | 12.7 | <b>C148</b>  | £22.05                  | -      |

| Bearings | Emm | Product Ref. | Price |
|----------|-----|--------------|-------|
| 25.0mmØ  | 3.2 | <b>B25A</b>  | £9.45 |
| 22.0mmØ  | 4.8 | <b>B22A</b>  | £9.45 |
| 19.0mmØ  | 6.3 | <b>B19A</b>  | £6.62 |
| 16.0mmØ  | 7.9 | <b>B16A</b>  | £5.25 |

| Spare Bearing | Emm | Product Ref. | Price |
|---------------|-----|--------------|-------|
| 12.7mmØ       | 9.5 | <b>B127A</b> | £4.10 |

## Bearing Guided One Piece Biscuit Jointer

This two wing self-guiding Tungsten Carbide Tipped slotting cutter is ideal for biscuit jointing. The set is supplied with three ball bearing guides to suit the three sizes of biscuits available. A slightly longer cut than the length of the biscuit is required for ease of alignment during assembly.

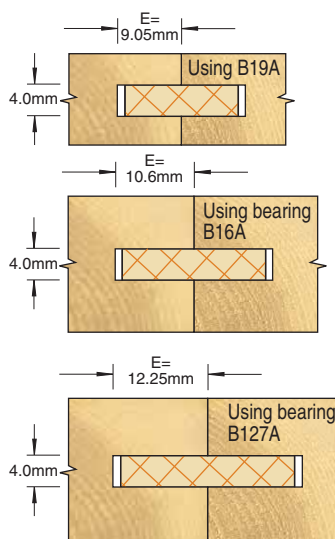

Profiles showing cross-section of biscuit joints.

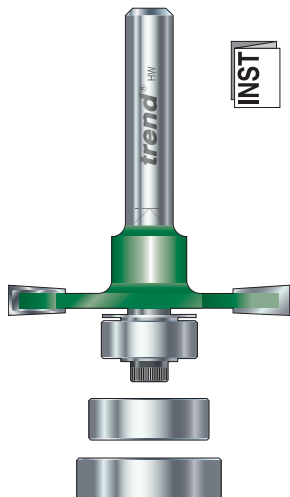
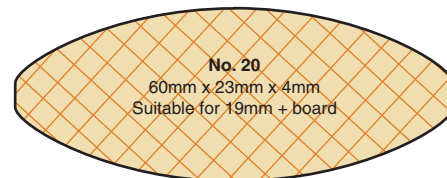
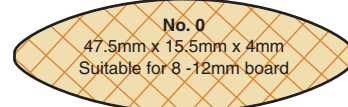

INST Instructions supplied

For biscuit prices see page 170.



| D mm | C mm | B mm | B2 mm | B3 mm | Product Ref. | 1/4" 8mm | Shank Diameter 12mm | 1/2" 12mm | Price  |
|------|------|------|-------|-------|--------------|----------|---------------------|-----------|--------|
| 37.2 | 4.0  | 12.7 | 16.0  | 19.0  | <b>C152</b>  | £33.08   | £33.08              | £33.08    | £33.08 |

| Spare Bearings | Product Ref. | Price |
|----------------|--------------|-------|
| 12.7mmØ        | <b>B127A</b> | £4.10 |
| 16.0mmØ        | <b>B16A</b>  | £5.25 |
| 19.0mmØ        | <b>B19A</b>  | £6.62 |

